

**STK4044II**

AF Power Amplifier (Split Power Supply) (100W min, THD = 0.4%)

Features

- Compact package for thin-type audio sets
- Member of pin-compatible series with outputs of 20 to 200W
- Easy heatsink design to disperse heat generated in thin-type stereo sets
- Constant-current circuit to reduce supply switch-on and switch-off shock noise
- External supply switch-on and switch-off shock noise muting, load short-circuit protection, thermal shutdown and other circuits can be tailored-designed.

Package Dimensions

unit: mm

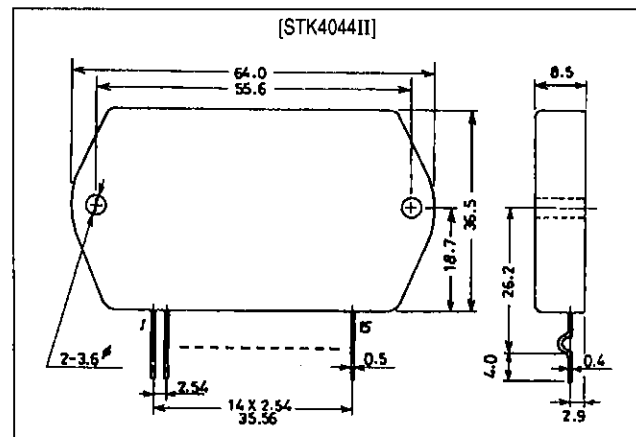
4075**Specifications****Maximum Ratings** at $T_a = 25^\circ\text{C}$

Parameter	Symbol	Conditions	Ratings	Unit
Maximum supply voltage	$V_{CC \text{ max}}$		± 73	V
Thermal resistance	θ_{j-c}		1.1	$^\circ\text{C/W}$
Junction temperature	T_j		150	$^\circ\text{C}$
Operating substrate temperature	T_c		125	$^\circ\text{C}$
Storage temperature	T_{stg}		-30 to +125	$^\circ\text{C}$
Available time for load short-circuit ¹	t_s	$V_{CC} = \pm 51\text{V}$, $R_L = 8\Omega$, $f = 50\text{Hz}$, $P_O = 100\text{W}$	1	s

Recommended Operating Conditions at $T_a = 25^\circ\text{C}$

Parameter	Symbol	Conditions	Ratings	Unit
Recommended supply voltage	V_{CC}		± 51	V
Load resistance	R_L		8	Ω

STK4044II

Operating Characteristics at $T_a = 25^\circ\text{C}$, $V_{CC} = \pm 51\text{V}$, $R_L = 8\Omega$ (noninductive load), $R_g = 600\Omega$, $V_G = 40\text{dB}$

Parameter	Symbol	Conditions	min	typ	max	Unit
Quiescent current	I_{CCO}	$V_{CC} = \pm 61\text{V}$	15	-	120	mA
Output power	P_O	THD = 0.4%, $f = 20\text{Hz}$ to 20kHz	100	-	-	W
Total harmonic distortion	THD	$P_O = 1.0\text{W}$, $f = 1\text{kHz}$	-	-	0.3	%
Frequency response	f_L, f_H	$P_O = 1.0\text{W}$, $+0_{-3}\text{dB}$	-	20 to 50k	-	Hz
Input impedance	r_i	$P_O = 1.0\text{W}$, $f = 1\text{kHz}$	-	55	-	k Ω
Output noise voltage ²	V_{NO}	$V_{CC} = \pm 61\text{V}$, $R_g = 10\text{k}\Omega$	-	-	1.2	mVrms
Neutral voltage	V_N	$V_{CC} = \pm 61\text{V}$	-70	0	+70	mV

Notes.

All tests are measured using a constant-voltage supply unless otherwise specified.

1. Output noise voltage is measured using the transformer supply specified below.

2. The output noise voltage is the peak value of an average-reading meter with an rms value scale. The noise voltage waveform does not include any pulse noise.

Specified Transformer Supply (MG-200 or Equivalent)

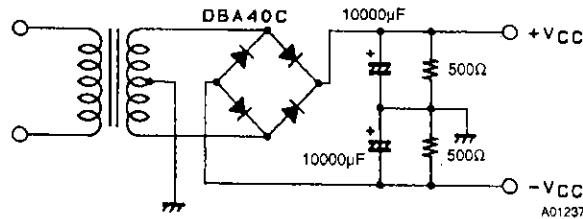

Equivalent Circuit

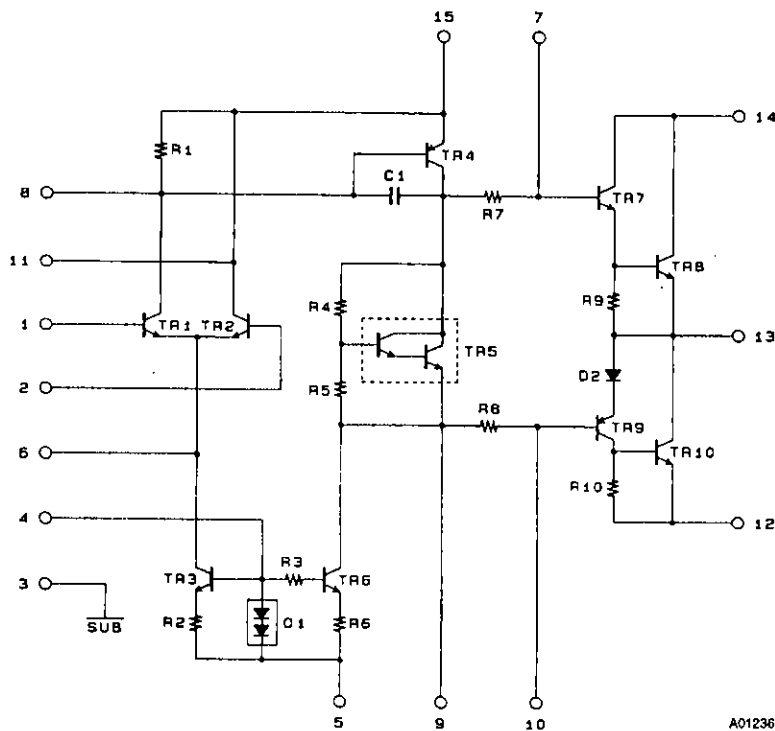

Sample Application Circuit (100W min AF Power Amplifier)

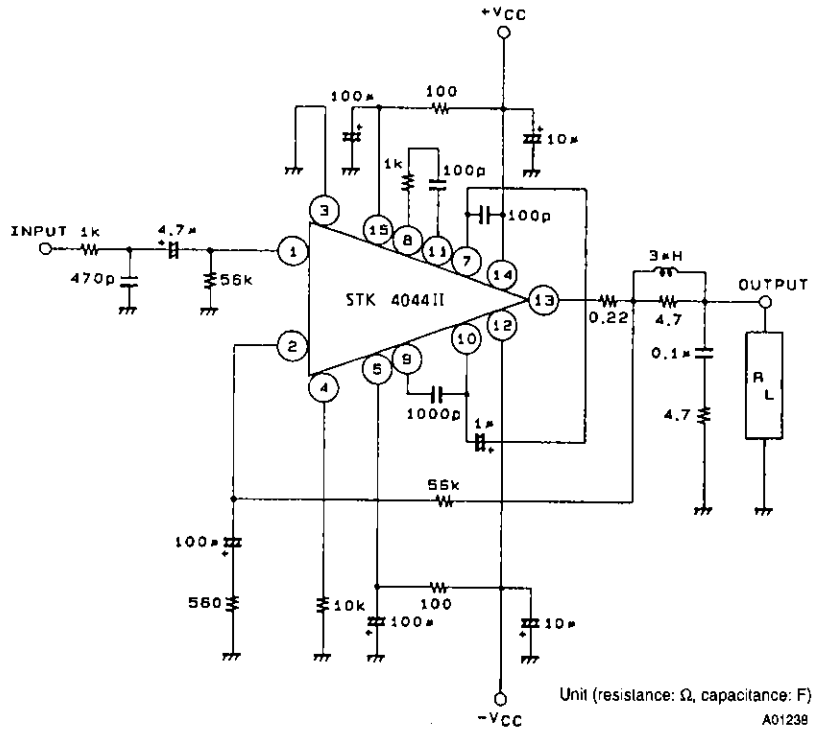

- No products described or contained herein are intended for use in surgical implants, life-support systems, aerospace equipment, nuclear power control systems, vehicles, disaster/crime-prevention equipment and the like, the failure of which may directly or indirectly cause injury, death or property loss.
- Anyone purchasing any products described or contained herein for an above-mentioned use shall:
 - ① Accept full responsibility and indemnify and defend SANYO ELECTRIC CO., LTD., its affiliates, subsidiaries and distributors and all their officers and employees, jointly and severally, against any and all claims and litigation and all damages, cost and expenses associated with such use:
 - ② Not impose any responsibility for any fault or negligence which may be cited in any such claim or litigation on SANYO ELECTRIC CO., LTD., its affiliates, subsidiaries and distributors or any of their officers and employees, jointly or severally.
- Information (including circuit diagrams and circuit parameters) herein is for example only; it is not guaranteed for volume production. SANYO believes information herein is accurate and reliable, but no guarantees are made or implied regarding its use or any infringements of intellectual property rights or other rights of third parties.