

SANYO	No.544G	2SA1011/2SC2344
PNP/NPN Epitaxial Planar Silicon Transistors High-Voltage Switching, AF Power Amp, 100W Output Predriver Applications		

() : 2SA1011

Maximum Ratings at Ta=25°C

			unit
Collector-to-Base Voltage	V_{CBO}	(-) 180	V
Collector-to-Emitter Voltage	V_{CEO}	(-) 160	V
Emitter-to-Base Voltage	V_{EBO}	(-) 6	V
Collector Current	I_C	(-) 1.5	A
Collector Current (Pulse)	I_{CP}	(-) 3	A
Collector Dissipation	P_C	25	W
Junction Temperature	T_j	150	°C
Storage Temperature	T_{stg}	- 55 to + 150	°C

$T_c=25^\circ C$

Electrical Characteristics at Ta=25°C

			min	typ	max	unit
Collector Cutoff Current	I_{CBO}	$V_{CB} = (-) 120V, I_E = 0$			(-) 10	μA
Emitter Cutoff Current	I_{EBO}	$V_{EB} = (-) 4V, I_C = 0$			(-) 10	μA
DC Current Gain	h_{FE}	$V_{CE} = (-) 5V, I_C = (-) 300mA$	60 ※		200 ※	
Gain-Bandwidth Product	f_T	$V_{CE} = (-) 10V, I_C = (-) 50mA$		100		MHz
Output Capacitance	C_{ob}	$V_{CB} = (-) 10V, f = 1MHz$		(30)		pF
				23		pF
Base-to-Emitter Voltage	V_{BE}	$V_{CE} = (-) 5V, I_C = (-) 10mA$		(-) 1.5		V
C-E Saturation Voltage	$V_{CE(sat)}$	$I_C = (-) 500mA, I_B = (-) 50mA$		(- 0.5)		V
				0.3		V
C-B Breakdown Voltage	$V_{(BR) CBO}$	$I_C = (-) 1mA, I_E = 0$		(-) 180		V
C-E Breakdown Voltage	$V_{(BR) CEO}$	$I_C = (-) 1mA, I_{BE} = \infty$		(-) 160		V
E-B Breakdown Voltage	$V_{(BR) EBO}$	$I_E = (-) 1mA, I_C = 0$		(-) 6		V
Turn-ON Time	t_{on}	See specified Test Circuit.	(0.29)	0.15		μs
Fall Time	t_f	"	(0.19)	0.48		μs
Storage Time	t_{stg}	"	(0.48)	0.81		μs

※ The 2SA1011/2SC2344 are classified by 300mA h_{FE} as follows :

60	D	120	100	E	200
----	---	-----	-----	---	-----

Switching Time Test Circuit

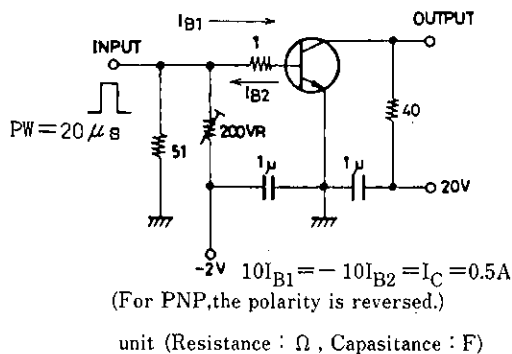

Package Dimensions 2010C

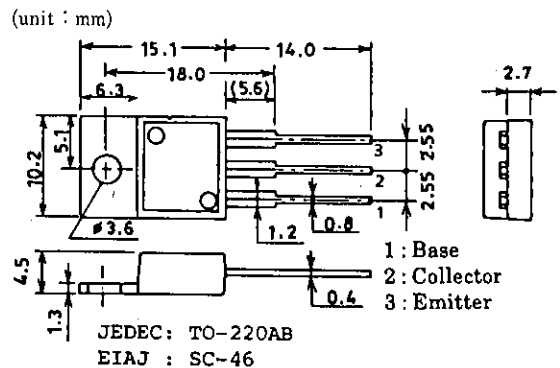

2SA1011/2SC2344

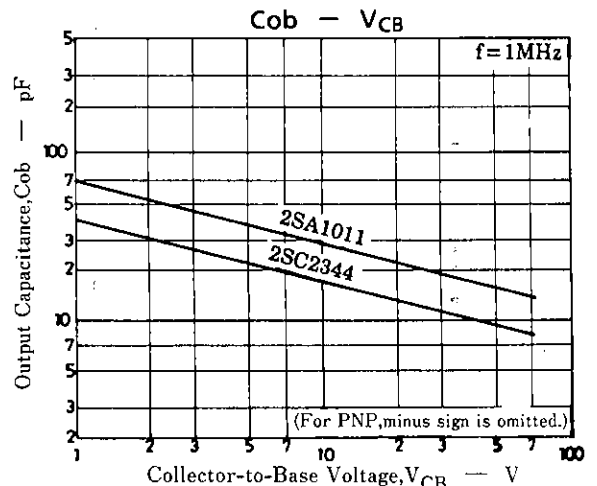
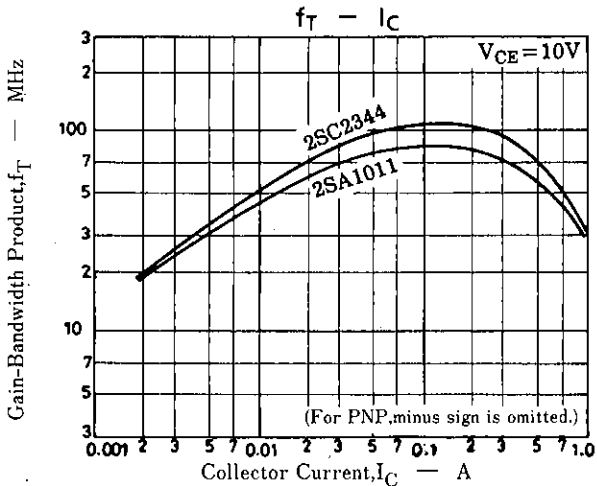
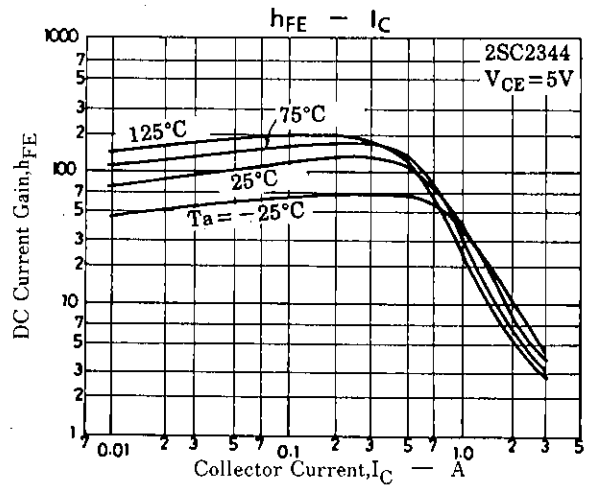
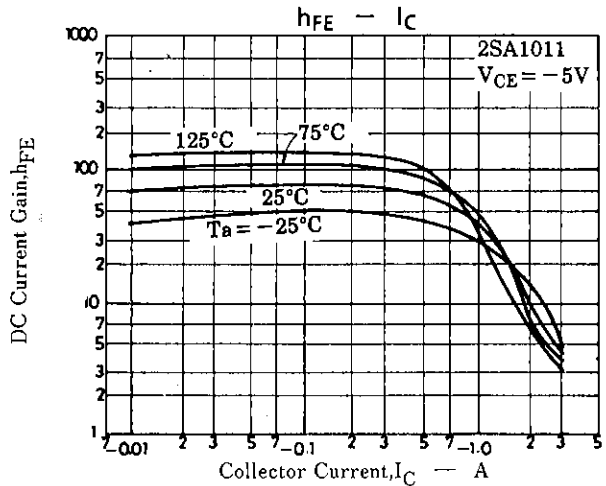
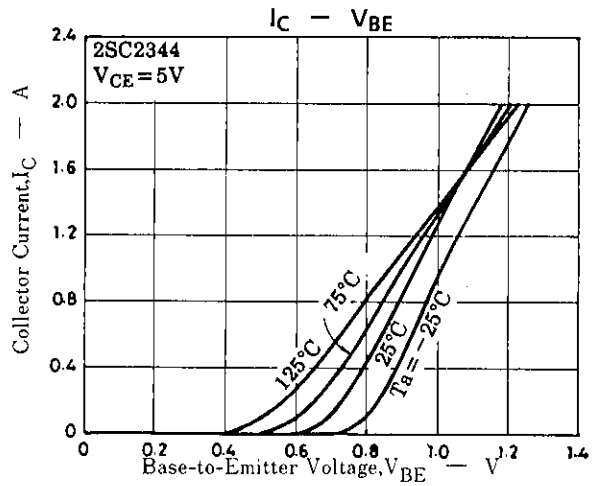
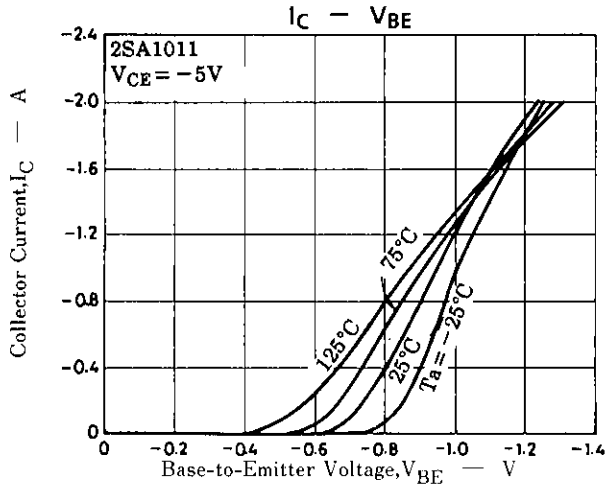
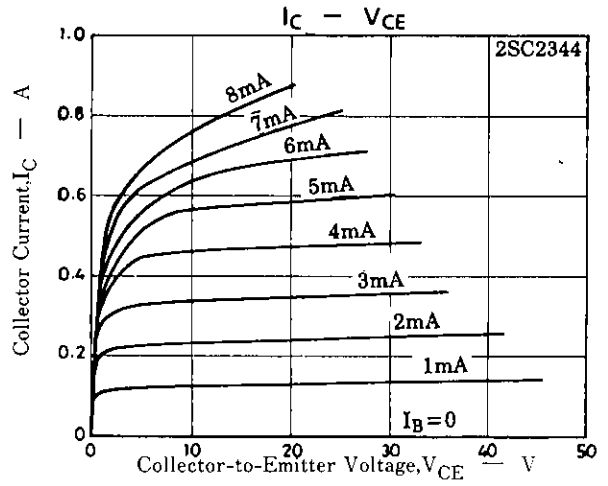
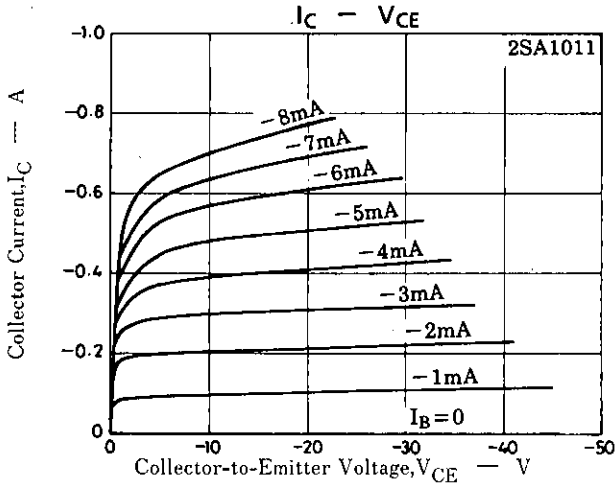

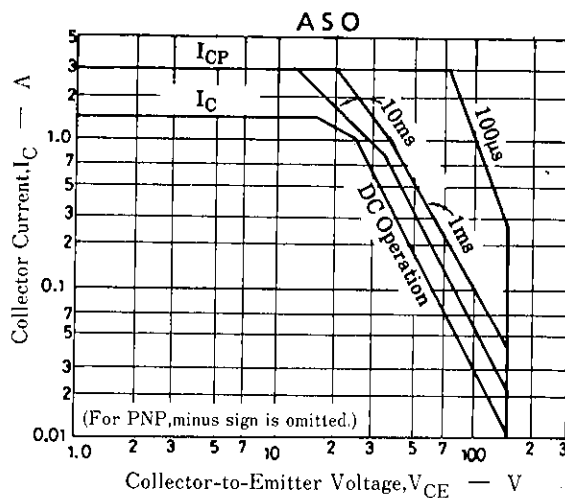
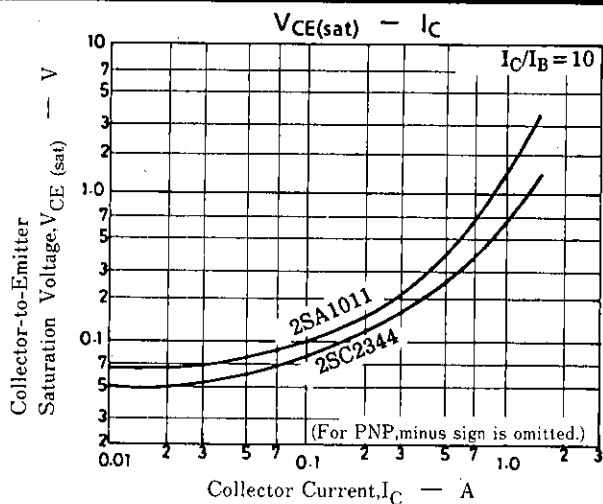

■ No products described or contained herein are intended for use in surgical implants, life-support systems, aerospace equipment, nuclear power control systems, vehicles, disaster/crime-prevention equipment and the like, the failure of which may directly or indirectly cause injury, death or property loss.

■ Anyone purchasing any products described or contained herein for an above-mentioned use shall:

- ① Accept full responsibility and indemnify and defend SANYO ELECTRIC CO., LTD., its affiliates, subsidiaries and distributors and all their officers and employees, jointly and severally, against any and all claims and litigation and all damages, cost and expenses associated with such use;
- ② Not impose any responsibility for any fault or negligence which may be cited in any such claim or litigation on SANYO ELECTRIC CO., LTD., its affiliates, subsidiaries and distributors or any of their officers and employees jointly or severally.

■ Information (including circuit diagrams and circuit parameters) herein is for example only; it is not guaranteed for volume production. SANYO believes information herein is accurate and reliable, but no guarantees are made or implied regarding its use or any infringements of intellectual property rights or other rights of third parties.

This catalog provides information as of March, 1996. Specifications and information herein are subject to change without notice.