

MOS FIELD EFFECT POWER TRANSISTORS  
**2SK1752/2SK1753**

**SWITCHING**  
**N-CHANNEL POWER MOS FET**  
**INDUSTRIAL USE**

**DESCRIPTION**

The 2SK1752/2SK1753 is N-channel MOS Field Effect Transistor designed for high voltage switching applications.

**FEATURES**

- Low On-state Resistance  
 $R_{DS(on)} \leq 0.9/1.0 \Omega$  ( $V_{GS} = 10 V, I_D = 5 A$ )
- Low  $C_{iss}$   $C_{iss} = 1060 pF$  TYP.
- Built-in G-S Gate Protection Diode
- High Avalanche Capability Ratings

**QUALITY GRADE**

Standard

Please refer to "Quality grade on NEC Semiconductor Devices" (Document number IEI-1209) published by NEC Corporation to know the specification of quality grade on the devices and its recommended applications.

**ABSOLUTE MAXIMUM RATINGS ( $T_a = 25^\circ C$ )**

Drain to Source Voltage	$V_{DSS}$	450/500	V
Gate to Source Voltage	$V_{GSS}$	$\pm 30$	V
Drain Current (DC)	$I_{D(DC)}$	$\pm 10$	A
Drain Current (pulse)	$I_{D(pulse)^*}$	$\pm 30$	A
Total Power Dissipation ( $T_c = 25^\circ C$ )	$P_T$	100	W
Channel Temperature	$T_{ch}$	150	$^\circ C$
Storage Temperature	$T_{stg}$	-55 to +150	$^\circ C$
Single Avalanche Current	$I_{AS}^{**}$	15	A
Single Avalanche Energy	$E_{AS}^{**}$	161	mJ

\*  $PW \leq 10 \mu s$ , Duty Cycle  $\leq 2\%$

\*\* Starting  $T_{ch} = 25^\circ C$ ,  $R_G = 25 \Omega$ ,  $V_{GS} = 20 V \rightarrow 0$

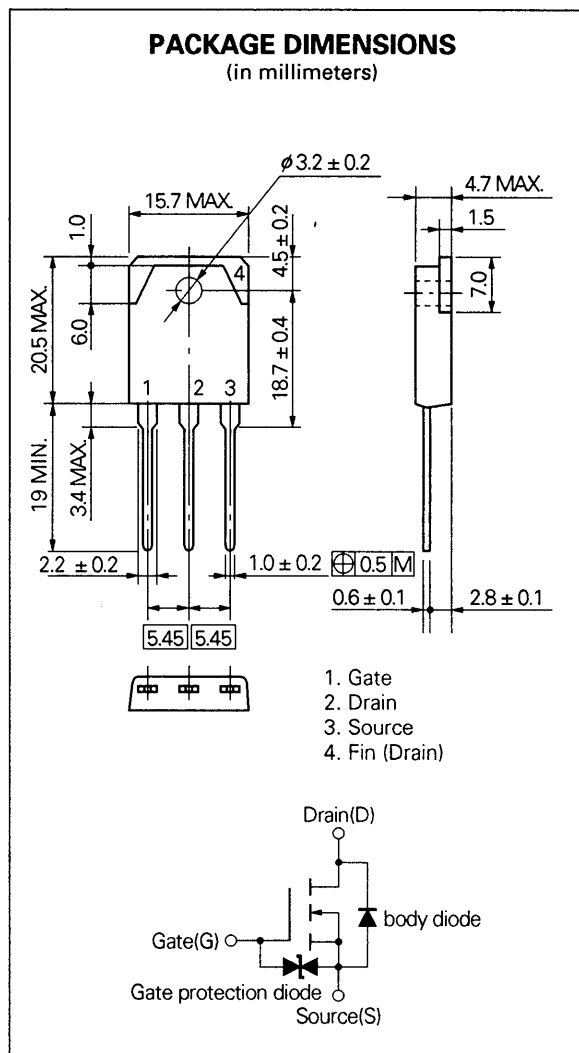

**ELECTRICAL CHARACTERISTICS (T<sub>a</sub> = 25 °C)**

CHARACTERISTIC	SYMBOL	MIN.	TYP.	MAX.	UNIT	TEST CONDITIONS
Drain to Source On-state Resistance (2SK1752)	R <sub>DS(on)</sub>		0.7	0.9	Ω	V <sub>GS</sub> = 10 V, I <sub>b</sub> = 5 A
Drain to Source On-state Resistance (2SK1753)	R <sub>DS(on)</sub>		0.8	1.0	Ω	
Gate to Source Cutoff Voltage	V <sub>GS(off)</sub>	2.5		3.5	V	V <sub>DS</sub> = 10 V, I <sub>b</sub> = 1 mA
Forward Transfer Admittance	y <sub>fs</sub>	3.5			S	V <sub>DS</sub> = 10 V, I <sub>b</sub> = 5 A
Drain Leakage Current	I <sub>DSS</sub>			100	μA	V <sub>DS</sub> = 450/500 V, V <sub>GS</sub> = 0
Gate to Source Leakage Current	I <sub>GSS</sub>			±10	μA	V <sub>GS</sub> = ±30 V, V <sub>DS</sub> = 0
Input Capacitance	C <sub>iss</sub>		1 060		pF	V <sub>DS</sub> = 10 V V <sub>GS</sub> = 0 f = 1 MHz
Output Capacitance	C <sub>oss</sub>		340		pF	
Reverse Transfer Capacitance	C <sub>rss</sub>		150		pF	
Turn-On Delay Time	t <sub>d(on)</sub>		20		ns	V <sub>GS</sub> = 10 V V <sub>DD</sub> = 150 V I <sub>b</sub> = 5 A, R <sub>G</sub> = 10 Ω R <sub>L</sub> = 30 Ω
Rise Time	t <sub>r</sub>		60		ns	
Turn-Off Delay Time	t <sub>d(off)</sub>		70		ns	
Fall Time	t <sub>f</sub>		20		ns	
Total Gate Charge	Q <sub>G</sub>		37		nC	
Gate to Source Charge	Q <sub>GS</sub>		7		nC	V <sub>GS</sub> = 10 V I <sub>b</sub> = 10 A V <sub>DD</sub> = 400 V
Gate to Drain Charge	Q <sub>GD</sub>		22		nC	
Diode Forward Voltage	V <sub>F(S-D)</sub>		1.0		V	I <sub>b</sub> = 10 A, V <sub>GS</sub> = 0
Reverse Recovery Time	t <sub>rr</sub>		480		ns	I <sub>b</sub> = 10 A, V <sub>GS</sub> = 0
Reverse Recovery Charge	Q <sub>rr</sub>		3.0		μC	di/dt = 50 A/μs

**Test Circuit 1: Avalanche Capability**

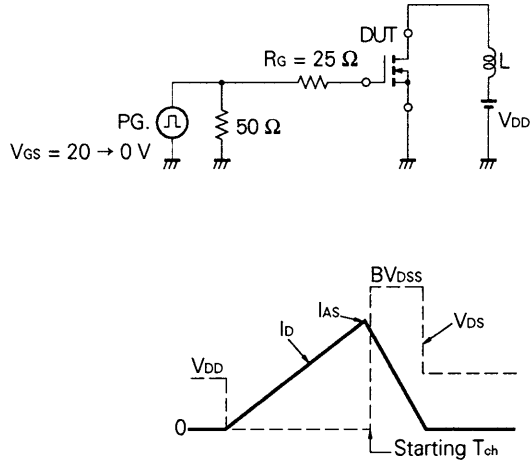

**Test Circuit 2: Switching Time**

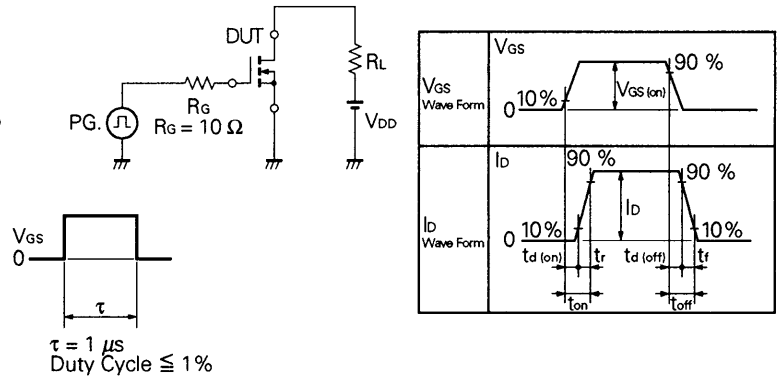

**Test Circuit 3: Gate Charge**

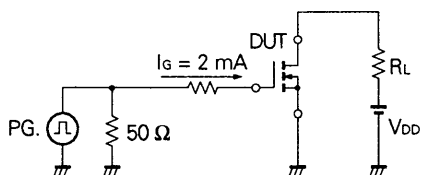

TYPICAL CHARACTERISTICS (T<sub>a</sub> = 25 °C)

DERATING FACTOR OF FORWARD BIAS SAFE OPERATING AREA

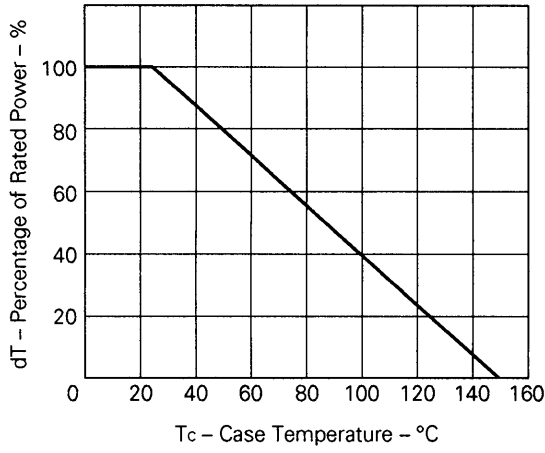

TOTAL POWER DISSIPATION vs. CASE TEMPERATURE

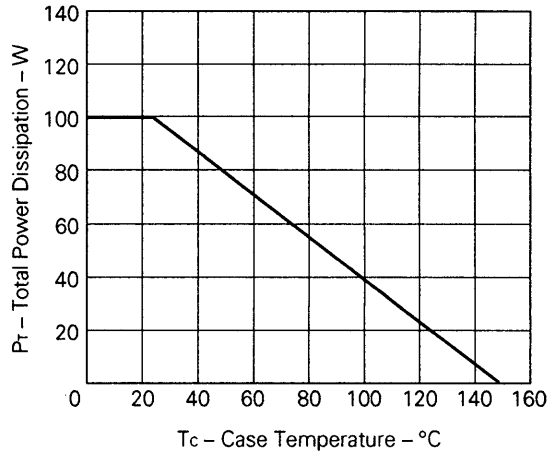

FORWARD BIAS SAFE OPERATING AREA

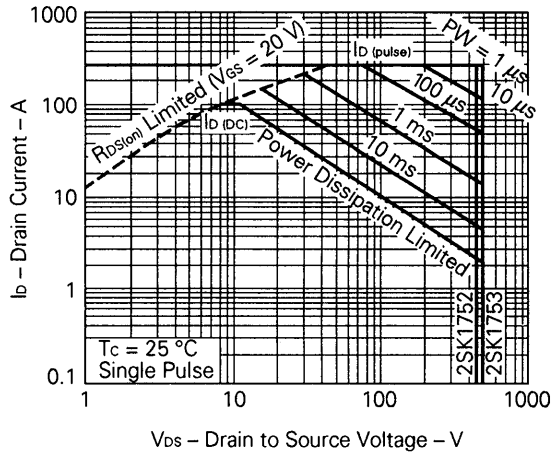

DRAIN CURRENT vs. DRAIN TO SOURCE VOLTAGE

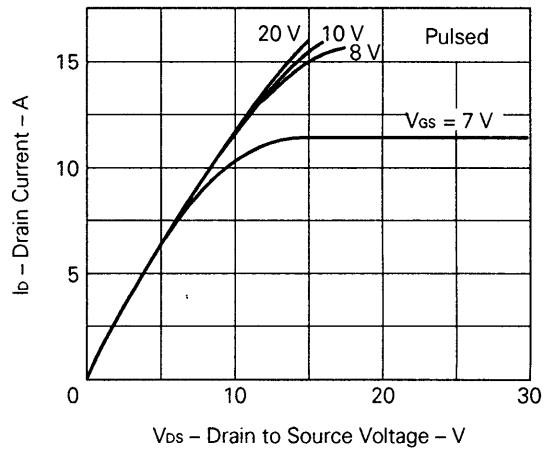

TRANSFER CHARACTERISTICS

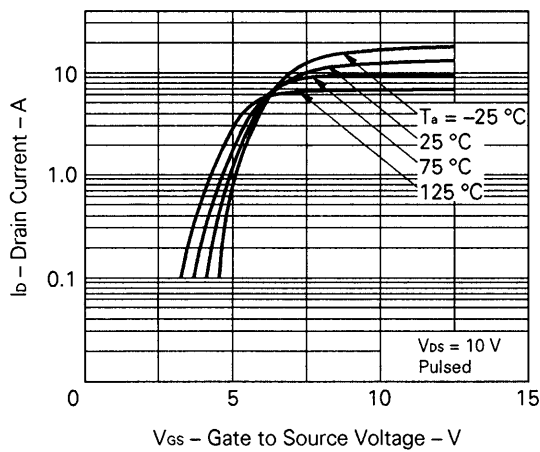

TRANSIENT THERMAL RESISTANCE vs. PULSE WIDTH

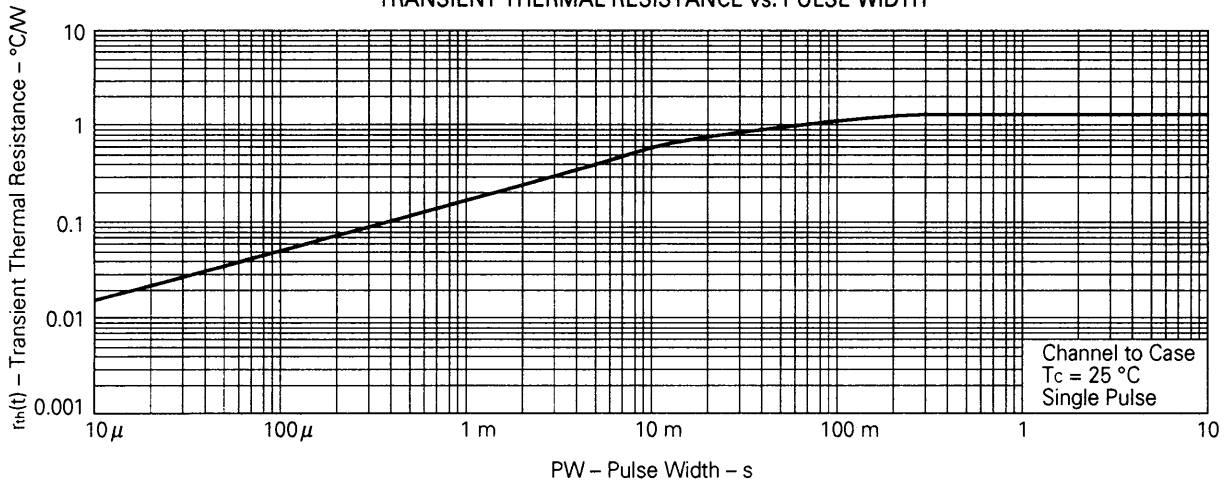

FORWARD TRANSFER ADMITTANCE vs. DRAIN CURRENT

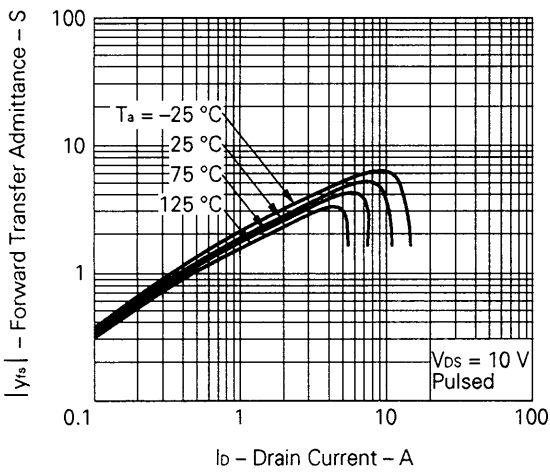

DRAIN TO SOURCE ON-STATE RESISTANCE vs. GATE TO SOURCE VOLTAGE

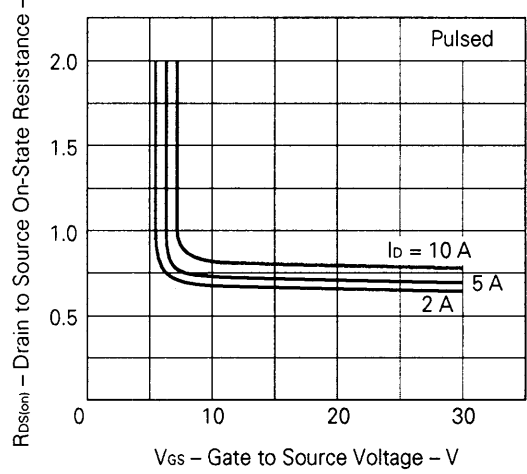

DRAIN TO SOURCE ON-STATE RESISTANCE vs. DRAIN CURRENT

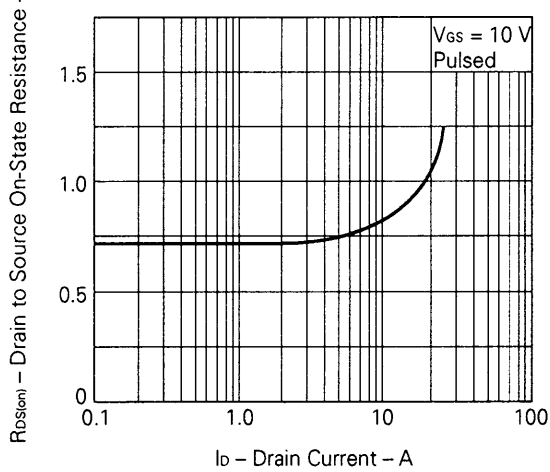

GATE TO SOURCE CUTOFF VOLTAGE vs. CHANNEL TEMPERATURE

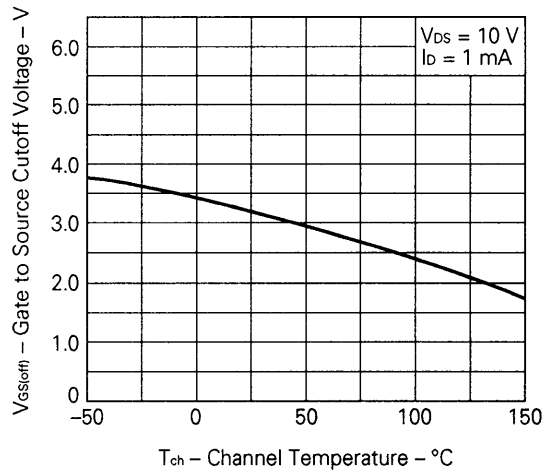

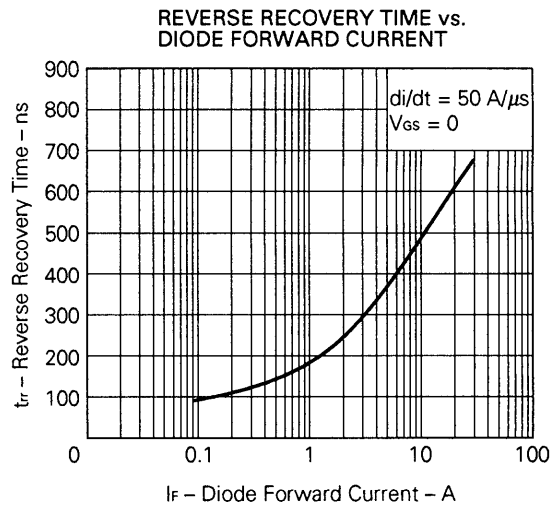
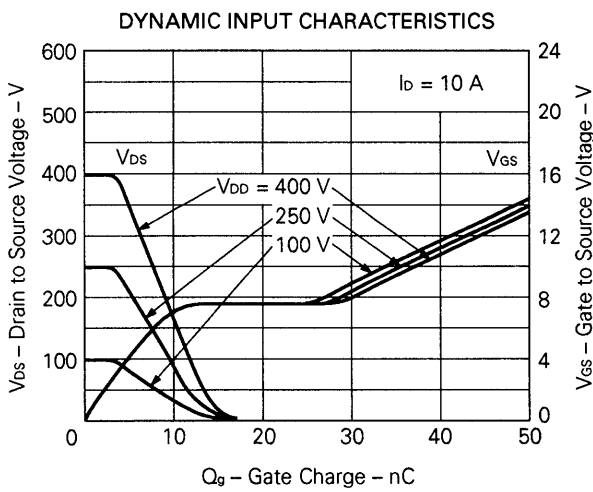
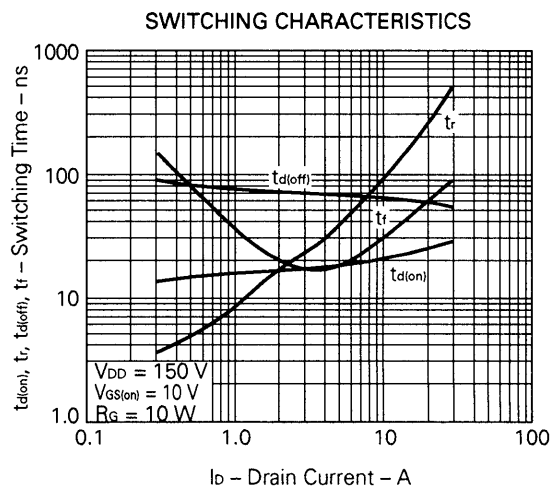
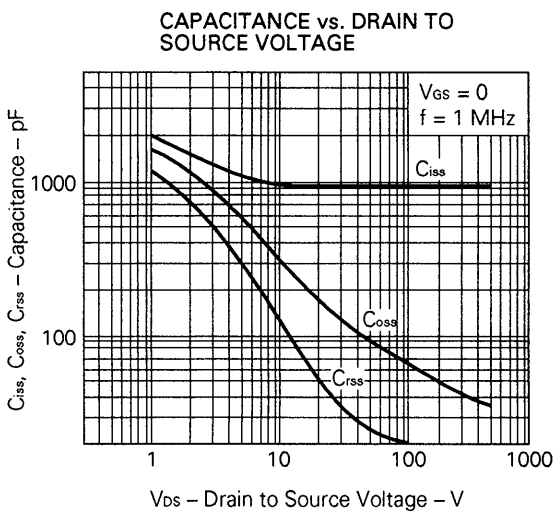
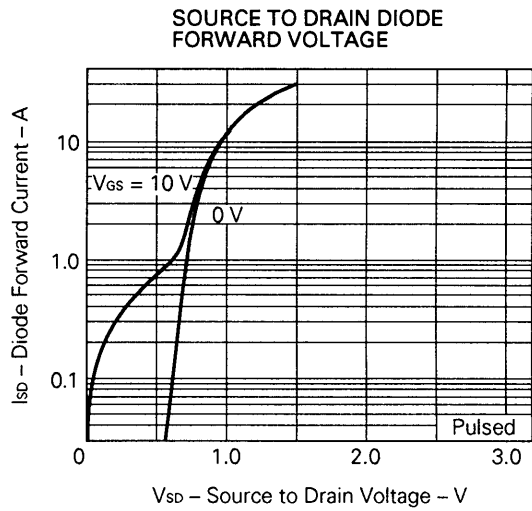
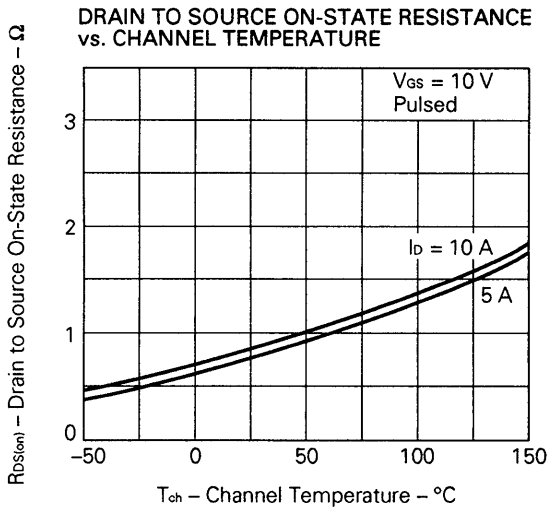

SINGLE AVALANCHE CURRENT vs. INDUCTIVE LOAD

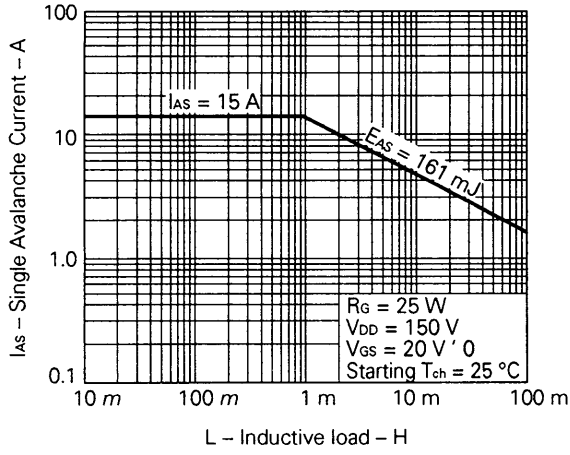

SINGLE AVALANCHE ENERGY vs. STARTING CHANNEL TEMPERATURE

