

> **Features**

- High Speed Switching
- Low On-Resistance
- No Secondary Breakdown
- Low Driving Power
- High Voltage
- $V_{GS} = \pm 30V$ Guarantee
- Repetitive Avalanche Rated

> **Applications**

- Switching Regulators
- UPS
- DC-DC converters
- General Purpose Power Amplifier

> **Maximum Ratings and Characteristics**

- Absolute Maximum Ratings ($T_C=25^\circ C$), unless otherwise specified

Item	Symbol	Rating	Unit
Drain-Source-Voltage	V_{DS}	600	V
Continous Drain Current	I_D	10	A
Pulsed Drain Current	$I_{D(puls)}$	36	A
Gate-Source-Voltage	V_{GS}	± 30	V
Repetitive or Non-Repetitive ($T_{ch} \leq 150^\circ C$)	I_{AR}	10	A
Avalanche Energy	E_{AS}	64,7	mJ
Max. Power Dissipation	P_D	50	W
Operating and Storage Temperature Range	T_{ch}	150	$^\circ C$
	T_{stg}	-55 ~ +150	$^\circ C$

> **Outline Drawing**

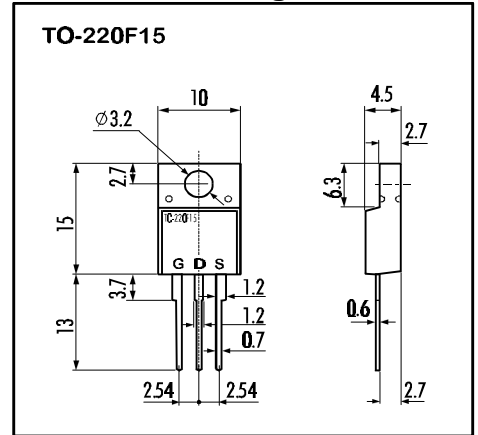

> **Equivalent Circuit**



- Electrical Characteristics ($T_C=25^\circ C$), unless otherwise specified

Item	Symbol	Test conditions	Min.	Typ.	Max.	Unit
Drain-Source Breakdown-Voltage	$V_{(BR)DSS}$	$I_D=1mA$ $V_{GS}=0V$	600			V
Gate Threshold Voltage	$V_{GS(th)}$	$I_D=1mA$ $V_{DS}=V_{GS}$	3,5	4,0	4,5	V
Zero Gate Voltage Drain Current	I_{DSS}	$V_{DS}=600V$ $T_{ch}=25^\circ C$		10	500	μA
		$V_{GS}=0V$ $T_{ch}=125^\circ C$		0,2	1,0	mA
Gate Source Leakage Current	I_{GSS}	$V_{GS}=\pm 30V$ $V_{DS}=0V$		10	100	nA
Drain Source On-State Resistance	$R_{DS(on)}$	$I_D=4,5A$ $V_{GS}=10V$		0,85	1,0	Ω
Forward Transconductance	g_{fs}	$I_D=5A$ $V_{DS}=25V$	3	6		S
Input Capacitance	C_{iss}	$V_{DS}=25V$		1100	1700	pF
Output Capacitance	C_{oss}	$V_{GS}=0V$		170	260	pF
Reverse Transfer Capacitance	C_{rss}	$f=1MHz$		75	120	pF
Turn-On-Time t_{on} ($t_{on}=t_{d(on)}+t_r$)	$t_{d(on)}$	$V_{CC}=300V$		25	40	ns
	t_r	$I_D=10A$		70	110	ns
Turn-Off-Time t_{off} ($t_{off}=t_{d(off)}+t_f$)	$t_{d(off)}$	$V_{GS}=10V$		75	120	ns
	t_f	$R_{GS}=10\Omega$		40	60	ns
Avalanche Capability	I_{AV}	$L=100\mu H$ $T_{ch}=25^\circ C$	10			A
Diode Forward On-Voltage	V_{SD}	$I_F=2I_{DR}$ $V_{GS}=0V$ $T_{ch}=25^\circ C$		1,0	1,5	V
Reverse Recovery Time	t_{rr}	$I_F=I_{DR}$ $V_{GS}=0V$		500		ns
Reverse Recovery Charge	Q_{rr}	$-dI_F/dt=100A/\mu s$ $T_{ch}=25^\circ C$		6,5		μC

- Thermal Characteristics

Item	Symbol	Test conditions	Min.	Typ.	Max.	Unit
Thermal Resistance	$R_{th(ch-a)}$	channel to air			62,5	$^\circ C/W$
	$R_{th(ch-c)}$	channel to case			2,5	$^\circ C/W$

> Characteristics

Typical Output Characteristics

$I_D=f(V_{DS})$; 80μs pulse test; $T_C=25^\circ\text{C}$

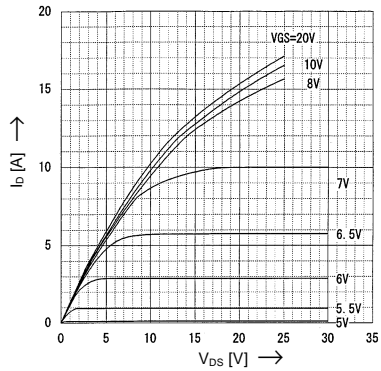

Drain-Source On-State Resistance vs. T_{ch}

$R_{DS(on)}=f(T_{ch})$; $I_D=4.5\text{A}$; $V_{GS}=10\text{V}$

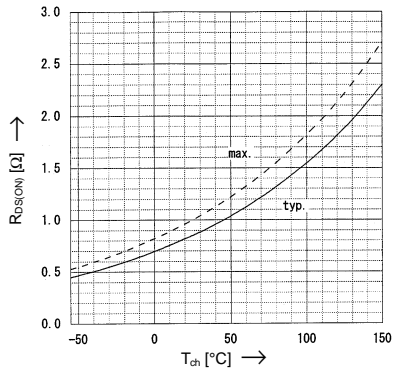

Typical Transfer Characteristics

$I_D=f(V_{GS})$; 80μs pulse test; $V_{DS}=25\text{V}$; $T_{ch}=25^\circ\text{C}$

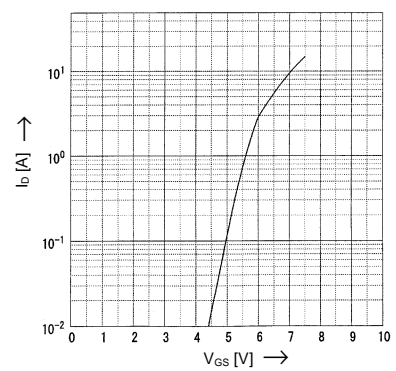

Typical Drain-Source On-State-Resistance vs. I_D

$R_{DS(on)}=f(I_D)$; 80μs pulse test; $T_C=25^\circ\text{C}$

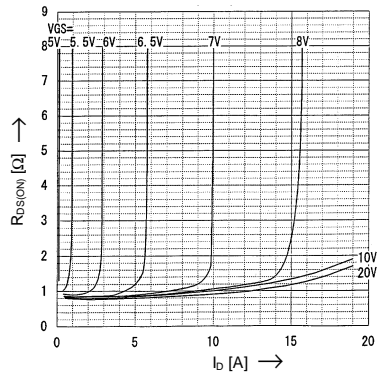

Typical Forward Transconductance vs. I_D

$g_{fs}=f(I_D)$; 80μs pulse test; $V_{DS}=25\text{V}$; $T_{ch}=25^\circ\text{C}$

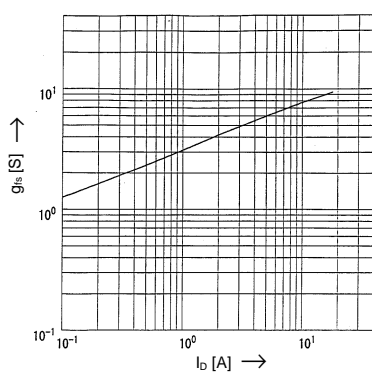

Gate Threshold Voltage vs. T_{ch}

$V_{GS(th)}=f(T_{ch})$; $I_D=1\text{mA}$; $V_{DS}=V_{GS}$

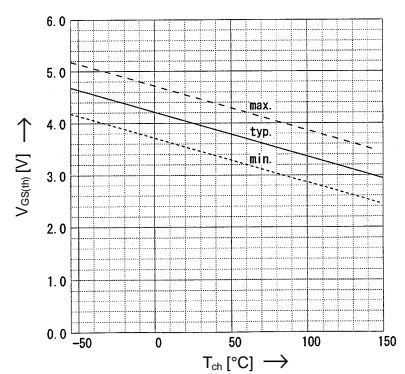

Typical Capacitances vs. V_{DS}

$C=f(V_{DS})$; $V_{GS}=0\text{V}$; $f=1\text{MHz}$

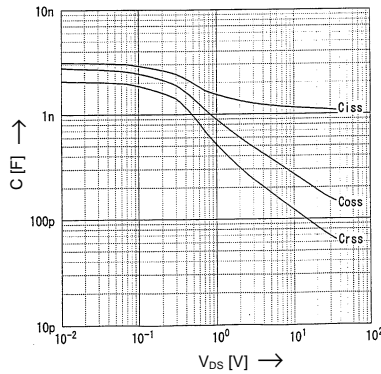

Typical Gate Charge Characteristic

$V_{GS}=f(Q_g)$; $I_D=10\text{A}$; $T_C=25^\circ\text{C}$

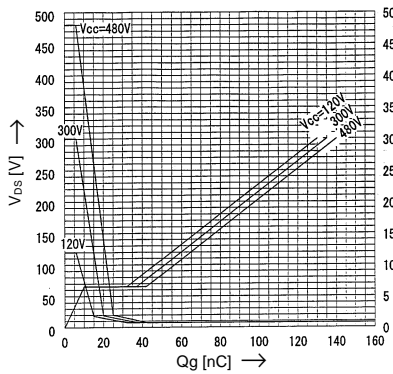

Forward Characteristics of Reverse Diode

$I_F=f(V_{SD})$; 80μs pulse test; $V_{GS}=0\text{V}$

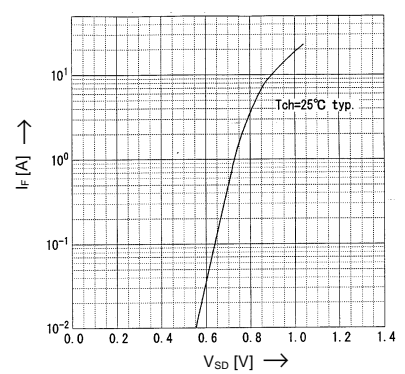

Avalanche Energy Derating

$E_{as}=f(\text{starting } T_{ch})$; $V_{CC}=60\text{V}$; $I_{AV}=10\text{A}$

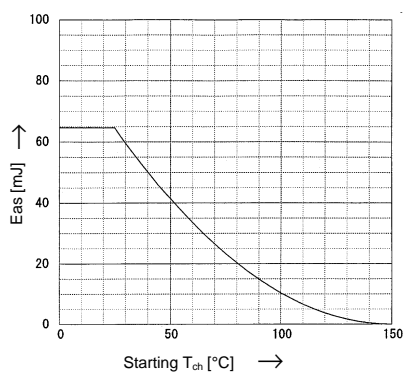

Safe Operation Area

$I_D=f(V_{DS})$; $D=0.01$; $T_C=25^\circ\text{C}$

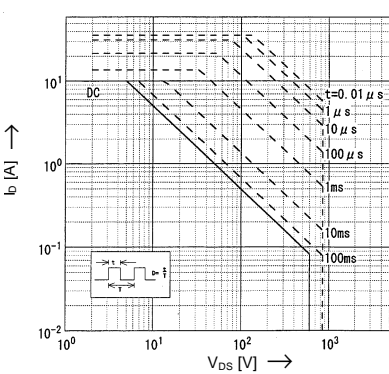

Transient Thermal Impedance

Transient Thermal Impedance

$Z_{th(ch-e)}=f(t)$ parameter: $D=t/T$

